

Design, Quality and Innovation 2011

30" wide appliances: HCB 1560/1561, HC 1540/1541



Fully Integrated Appliances 30"

Stylish and sleek the 30" fully integrated HCB 1560 offers impressive performance features and design flexibility. The smart DuoCooking system with separate exceptionally efficient variable speed compressors ensures no air is exchanged between compartments guaranteeing food won't dry out and the freezer is always ice free. Plus, frost buildup up to 5x longer with DefFresh that retains healthy vitamins, aroma and appetizing appearance. Each drawer can be adjusted individually and provides ideal humidity for versatile storage solutions.

The HC 1540 model is perfect for a seamless design because it is cleverly concealed behind cabinet doors. With a fully integrated HandLine door-on-door system that incorporates strong hinges for a convenient closing of doors even when fully loaded. Double freezer drawers mounted on smooth telescopic rails offer more than 4 cubic feet of storage space and the drawer system offers convenient handling and stacking of food stored. A water connection is not needed for the IceMaker thanks to a well appointed 1.5 liter internal water tank that is conveniently removable for replenishing water used to produce cubes that are just right.

HCB 1560 FreezerPlus Defrost Freezer



Capacity	
Refrigerator (net) cu ft. @	7.7 (218)
Refrigerator comp. cu ft. @	2.1 (60)
Refrigerator freezer comp. cu ft. @	4.3 (122)
Ice cube dimensions	
Ice cube (mm)	39 x 27 x 25 (1 1/2" x 1 1/8" x 1")
Ice on hand	200 (7 1/2 lbs)

Features

- 2 separately adjustable cooling controls for refrigerator and freezer compartments.

This unit is also available as:
 HCB 1561 with door hinges left, with water and door lock
 HC 1541 with door hinges left, with water tank and defrost button

Standard Glass Door (30" or 34" height) and Drawer options available

LIEBHERR

Design, Quality and Innovation 2011

HCB 156x, HC 154x – the new 30" platform

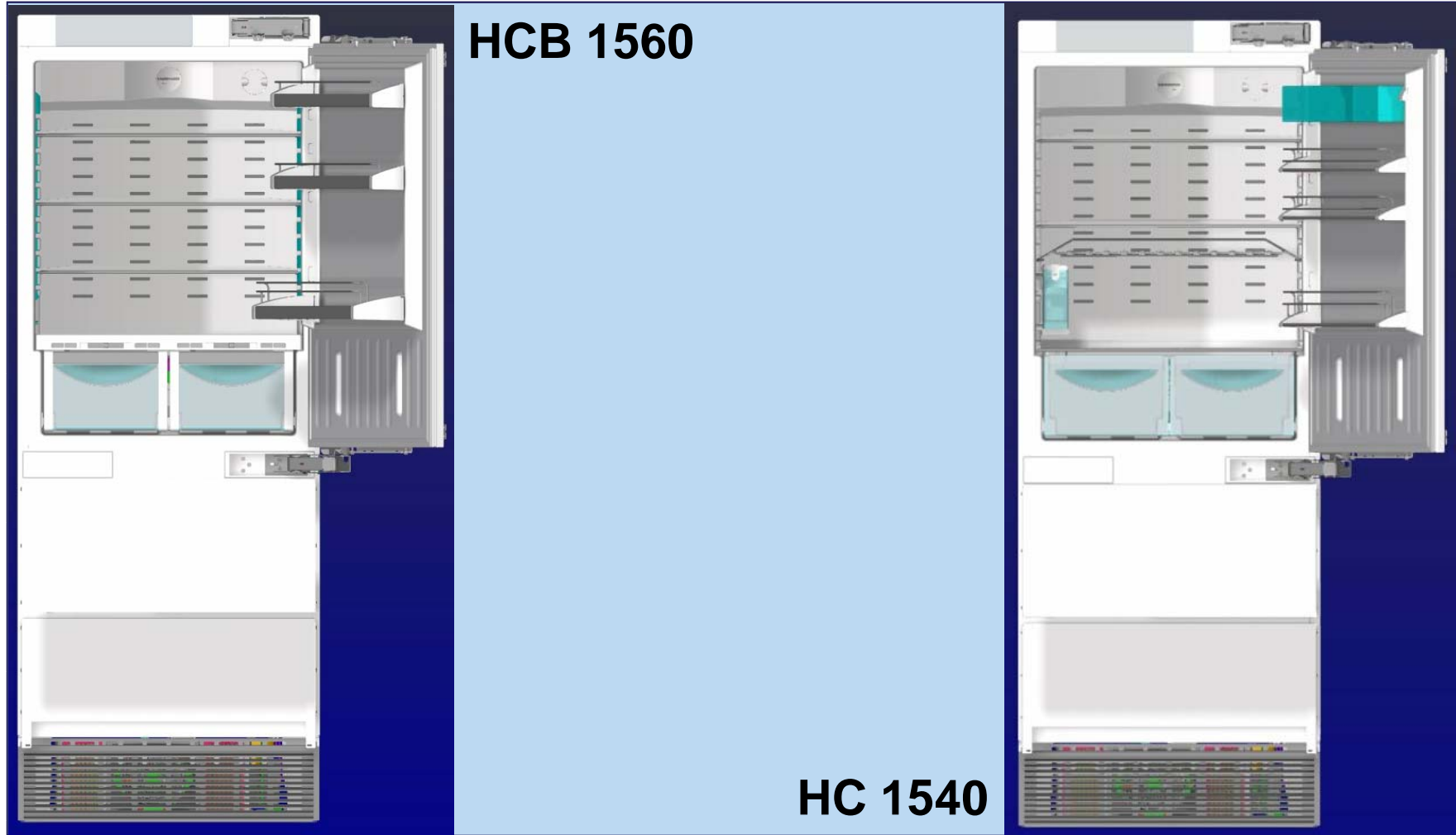

LIEBHERR

Design, Quality and Innovation 2011

HCB 156x, HC 154x – the new 30" platform



**Large Hettich-hinges
and eccentric touch
control panel**

**Door reversal through
service still possible!**

**PCB on top of unit,
cover flush with ceiling.**

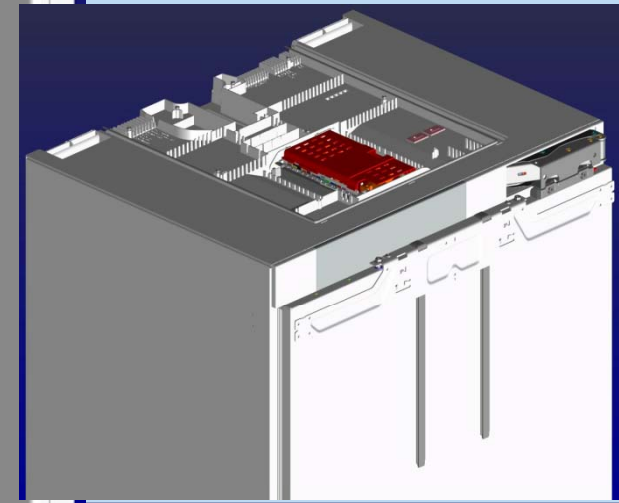

LIEBHERR

Design, Quality and Innovation 2011

HCB 156x, HC 154x – the new 30" platform

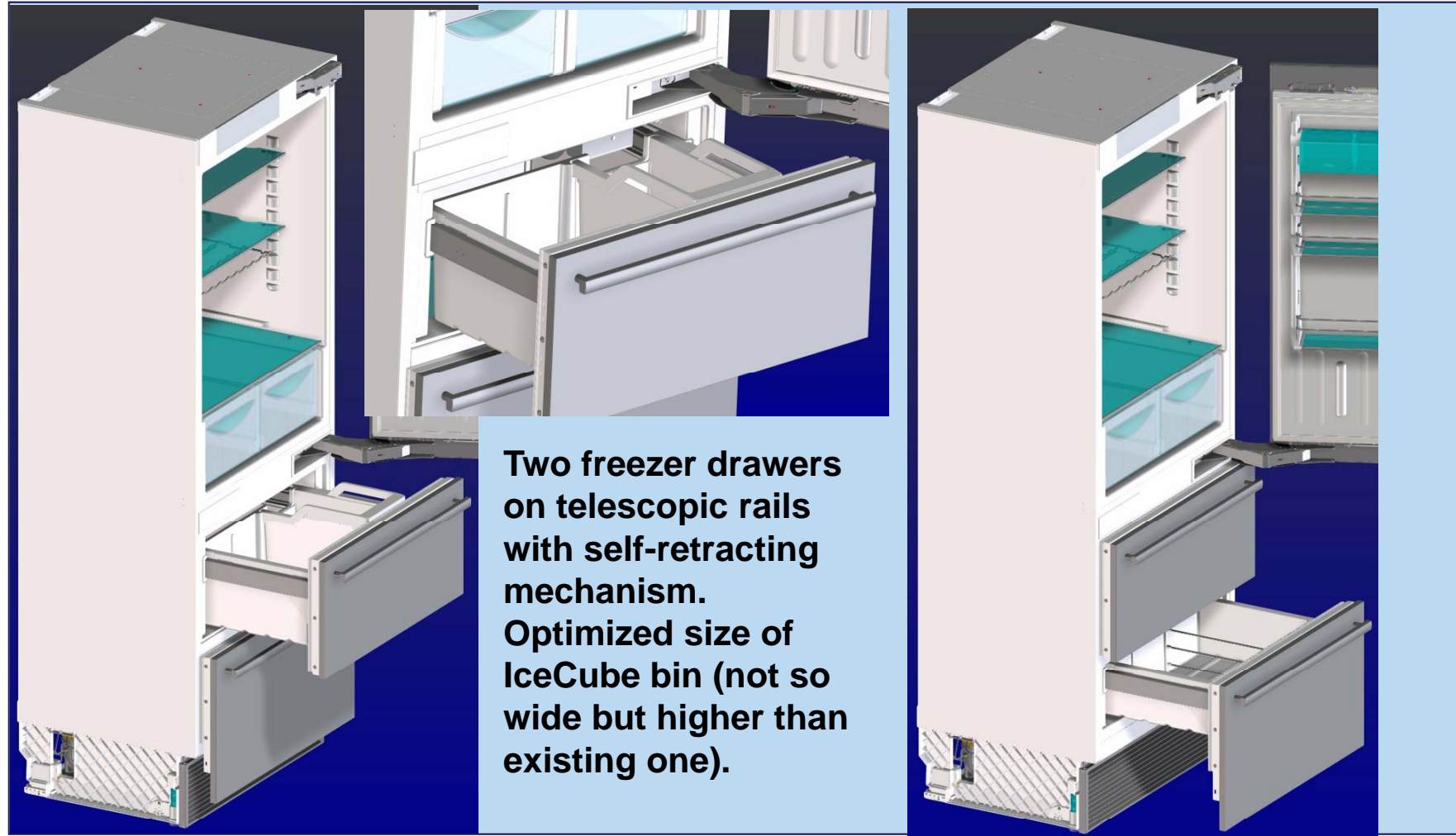

LIEBHERR

Design, Quality and Innovation 2011

HCB 156x, HC 154x – the new 30" platform

New plinth of 36" units is also used for HCB, HC 15.

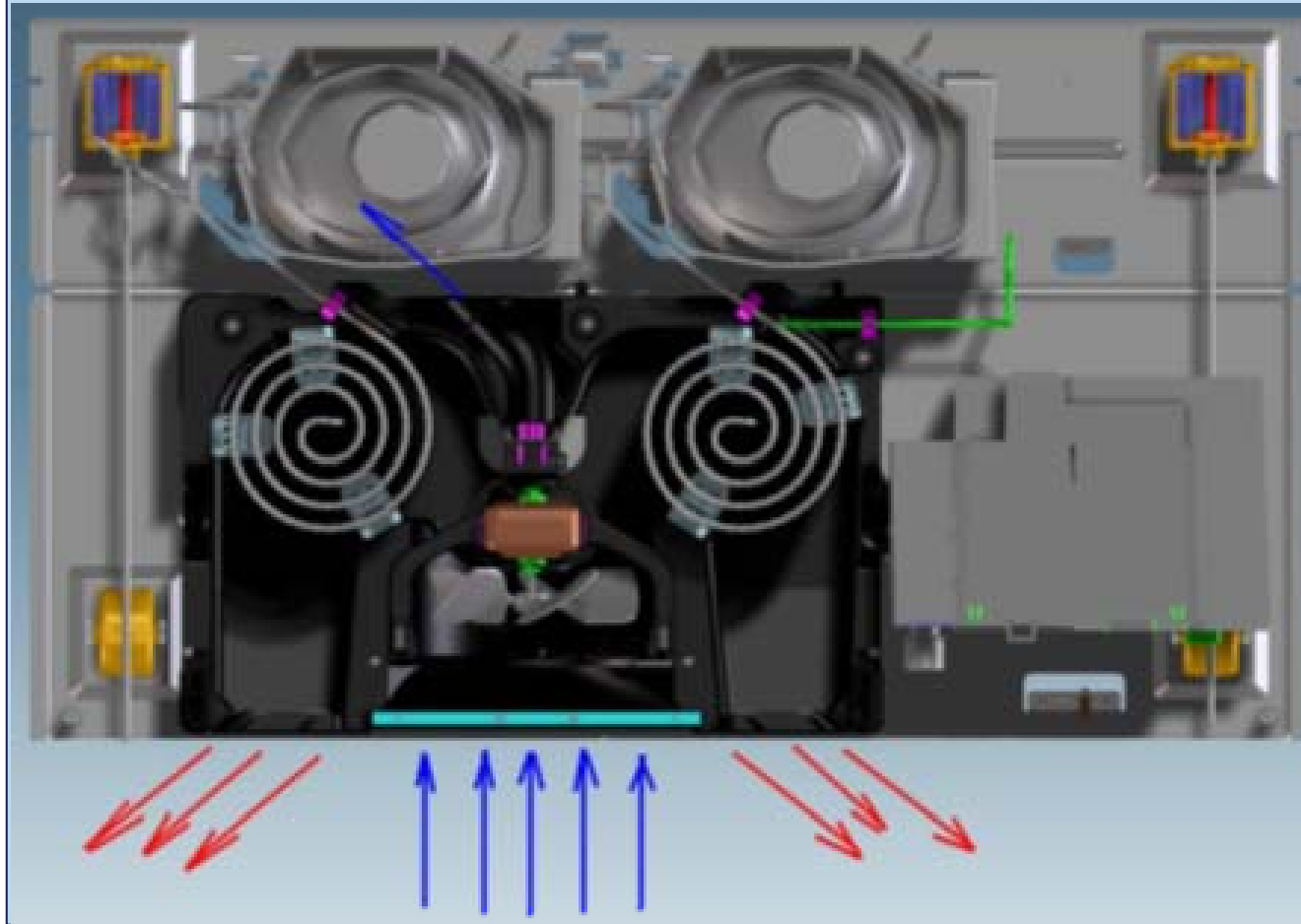

LIEBHERR

Design, Quality and Innovation 2011

HCB 156x, HC 154x – the new 30" platform

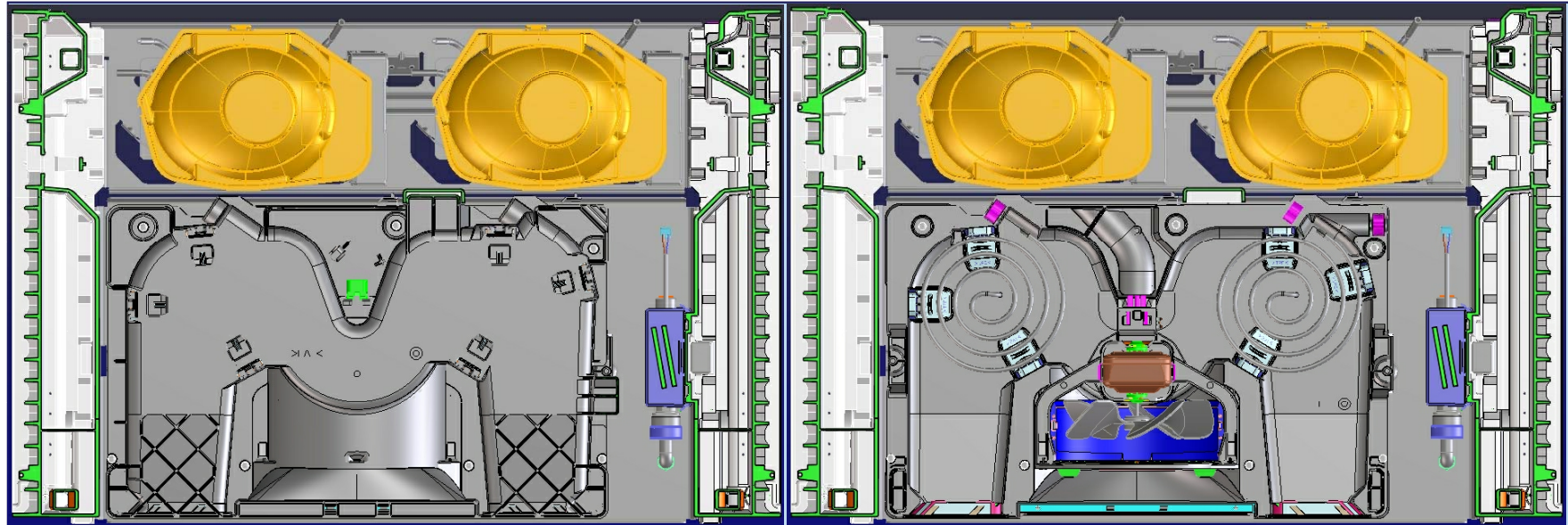

New plinth of 36" units is also used for HCB, HC 15.

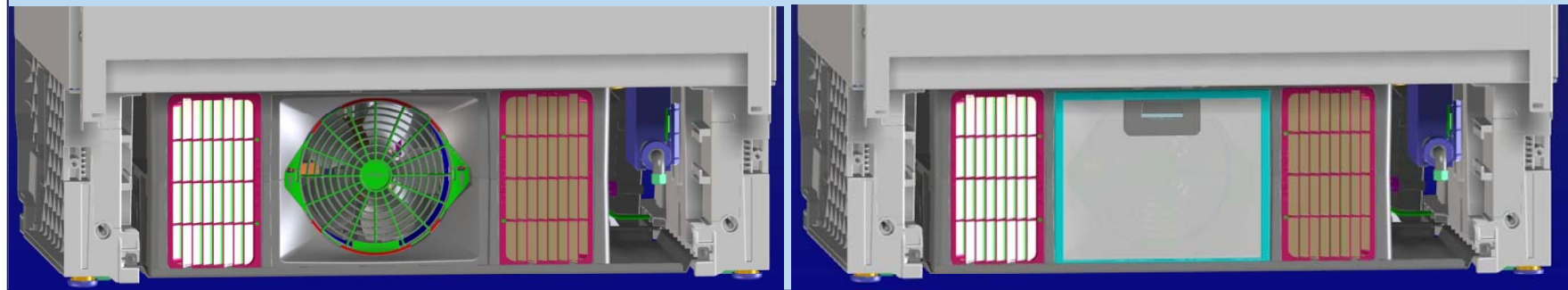

LIEBHERR

Design, Quality and Innovation 2011

HCB 156x, HC 154x – the new 30" platform

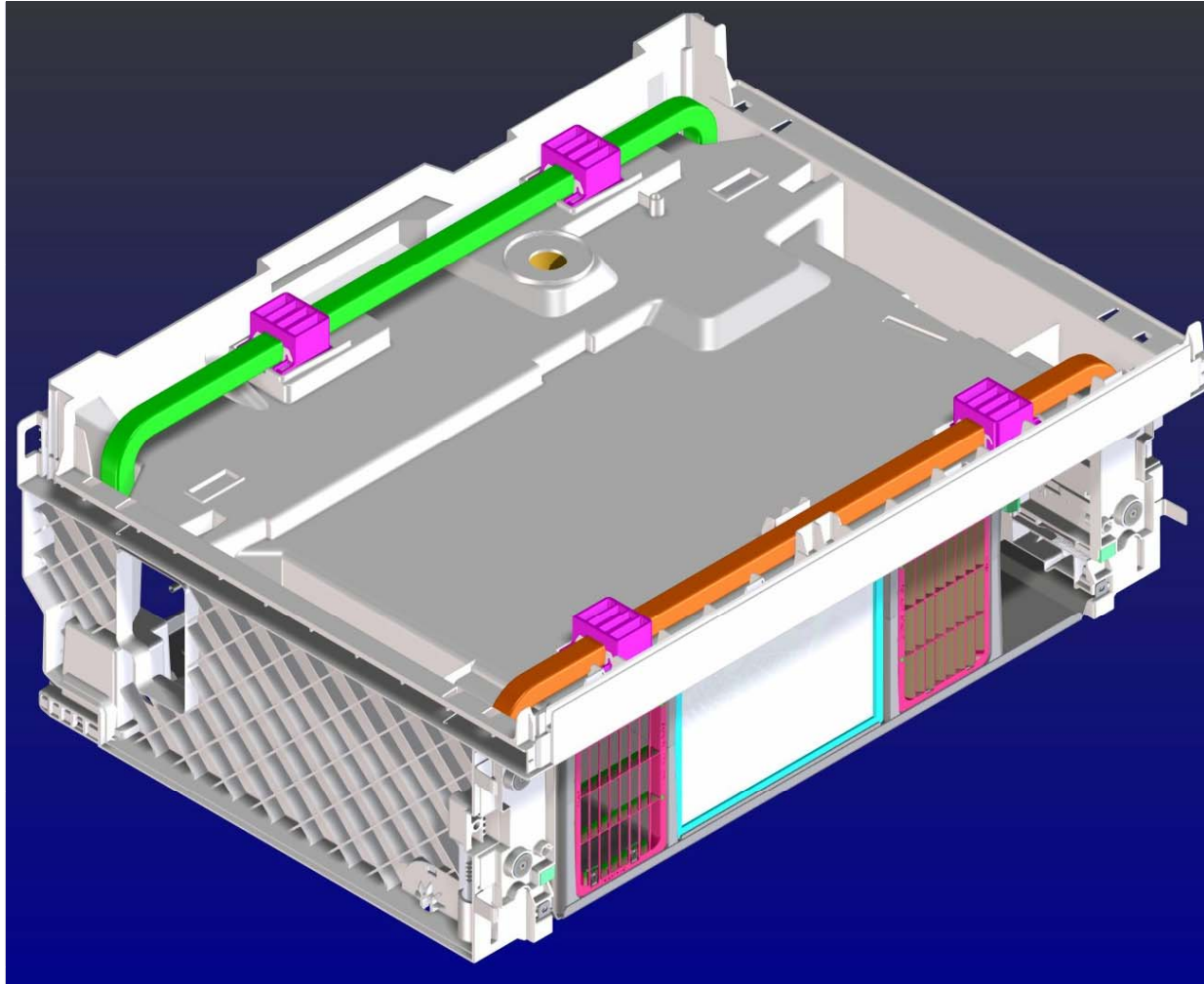

Stability is added to the whole plinth construction:

- reinforcements
- foamed sides
- honeycomb-structure

LIEBHERR

Design, Quality and Innovation 2011

HCB 156x, HC 154x – the new 30" platform

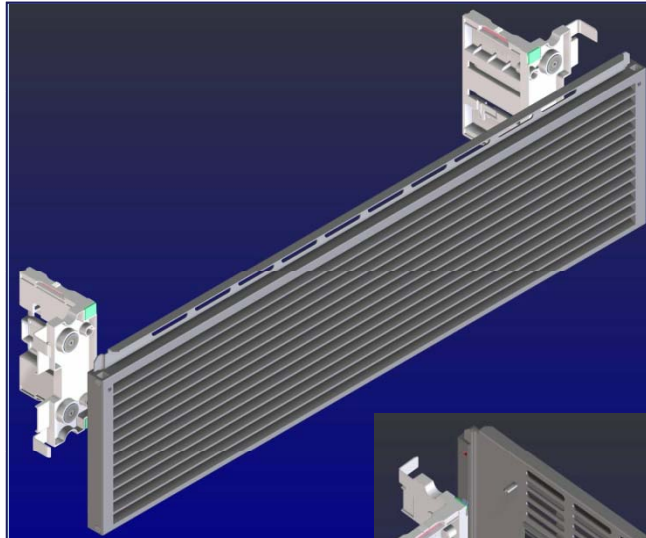

Ventilation grille is attached to the plinth with magnets. After first installation, e.g. for cleaning of air filter the grille can be removed easily without any tools.

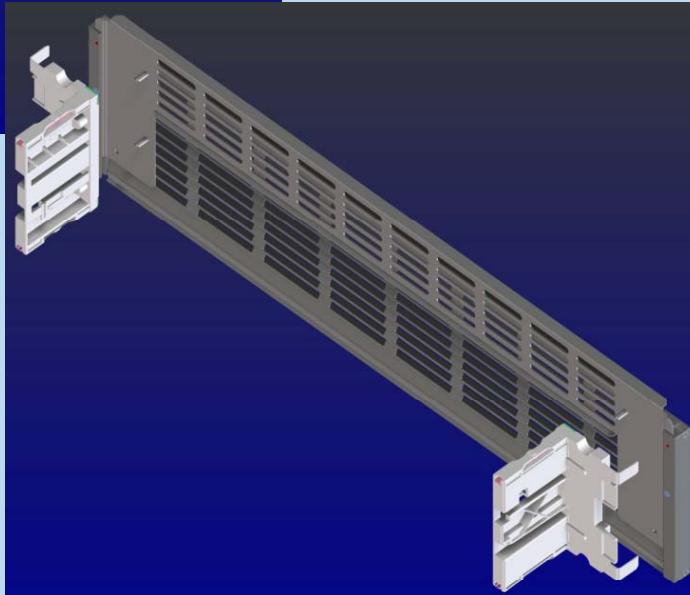

LIEBHERR

Design, Quality and Innovation 2011

HCB 156x, HC 154x – the new 30" platform

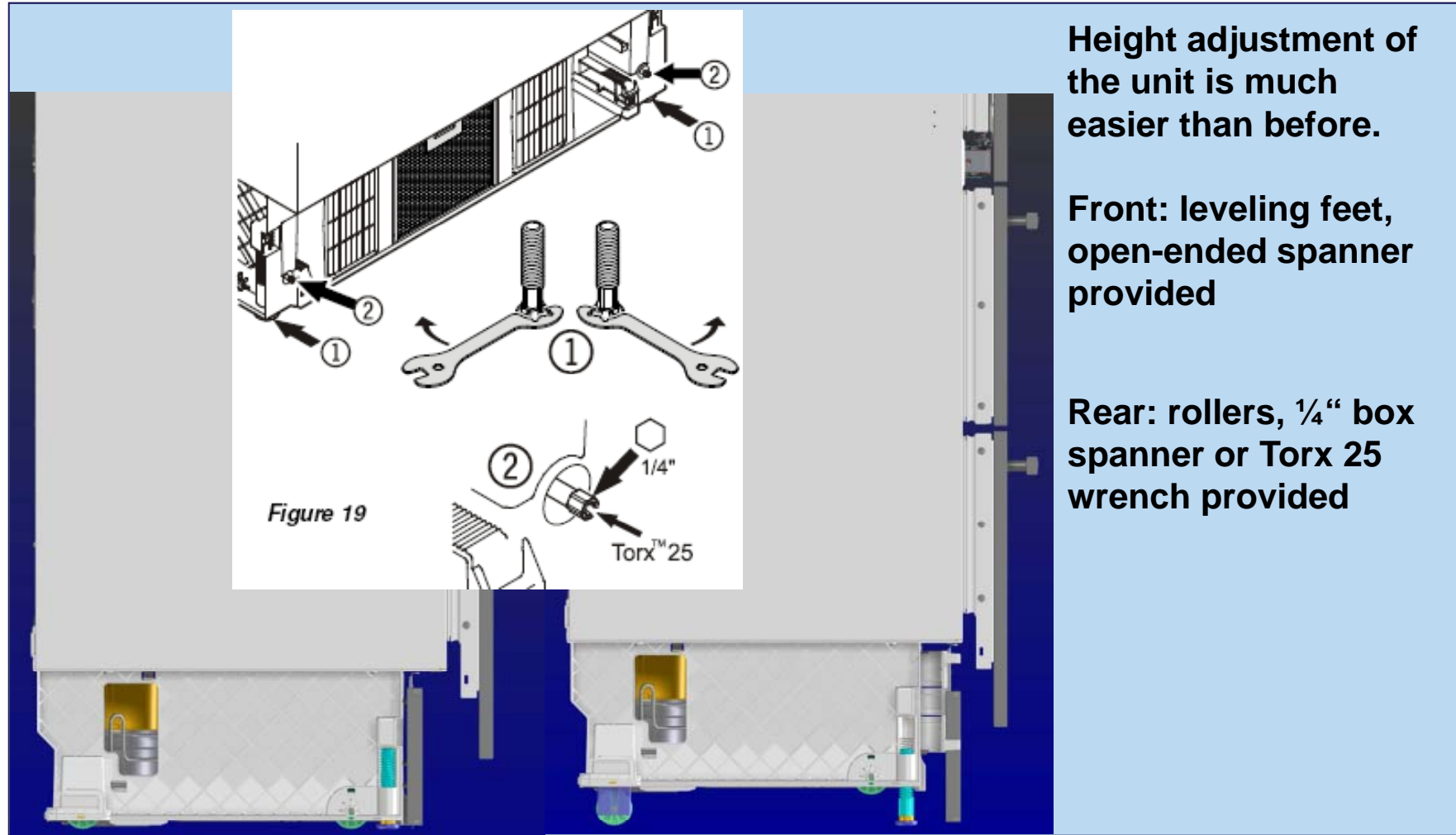

The image contains a technical diagram labeled 'Figure 19' and two photographs. The diagram shows a side view of a unit with leveling feet (1) and rollers (2). It includes a callout for a Torx™ 25 screw (2) with a 1/4" diameter. The photographs show the front and rear views of the units, highlighting the leveling feet and rollers respectively.

Figure 19

① leveling feet
② rollers

1/4"
Torx™ 25

Height adjustment of the unit is much easier than before.

Front: leveling feet, open-ended spanner provided

Rear: rollers, 1/4" box spanner or Torx 25 wrench provided

LIEBHERR

Design, Quality and Innovation 2011

HCB 156x, HC 154x – the new 30" platform

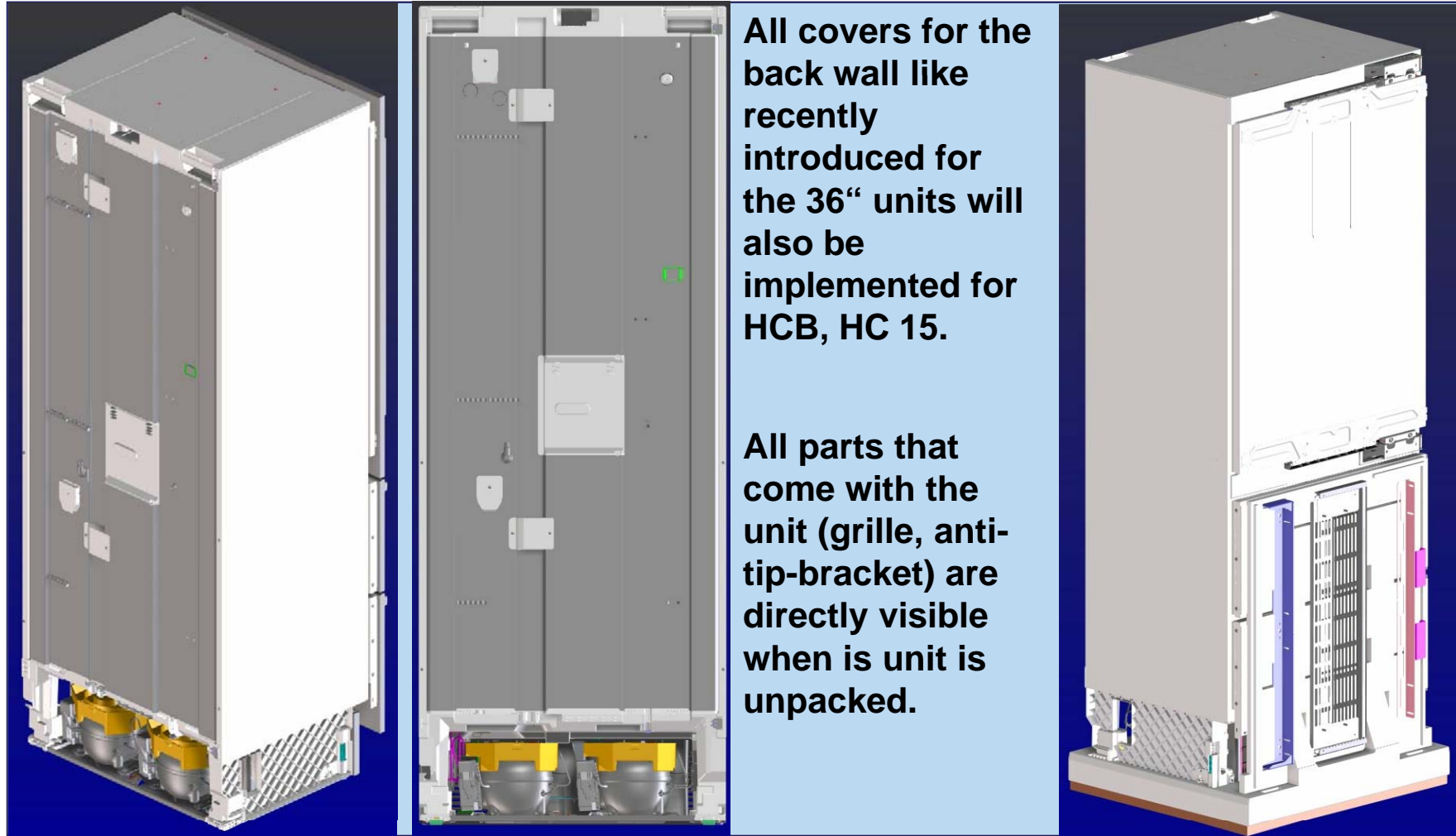

LIEBHERR

Design, Quality and Innovation 2011

HCB 156x, HC 154x – the differentiation

HCB 1560 Premium Plus

Also available with door hinges left as HCB 1561

HC 1540 Premium

Also available with door hinges left as HC 1541

LIEBHERR

Design, Quality and Innovation 2011

HCB 156x, HC 154x – the differentiation

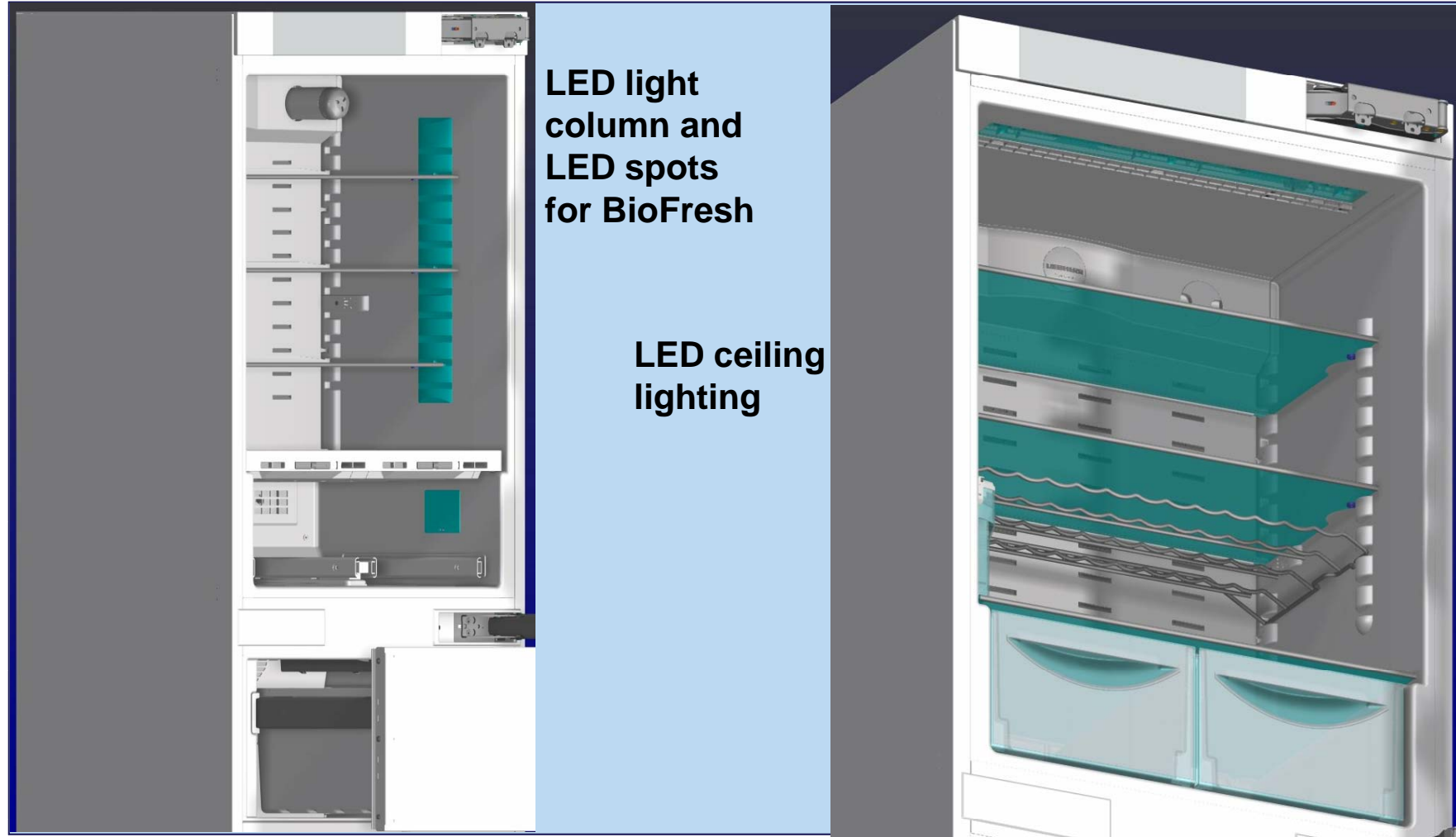

LIEBHERR

Design, Quality and Innovation 2011

HCB 156x, HC 154x – the differentiation

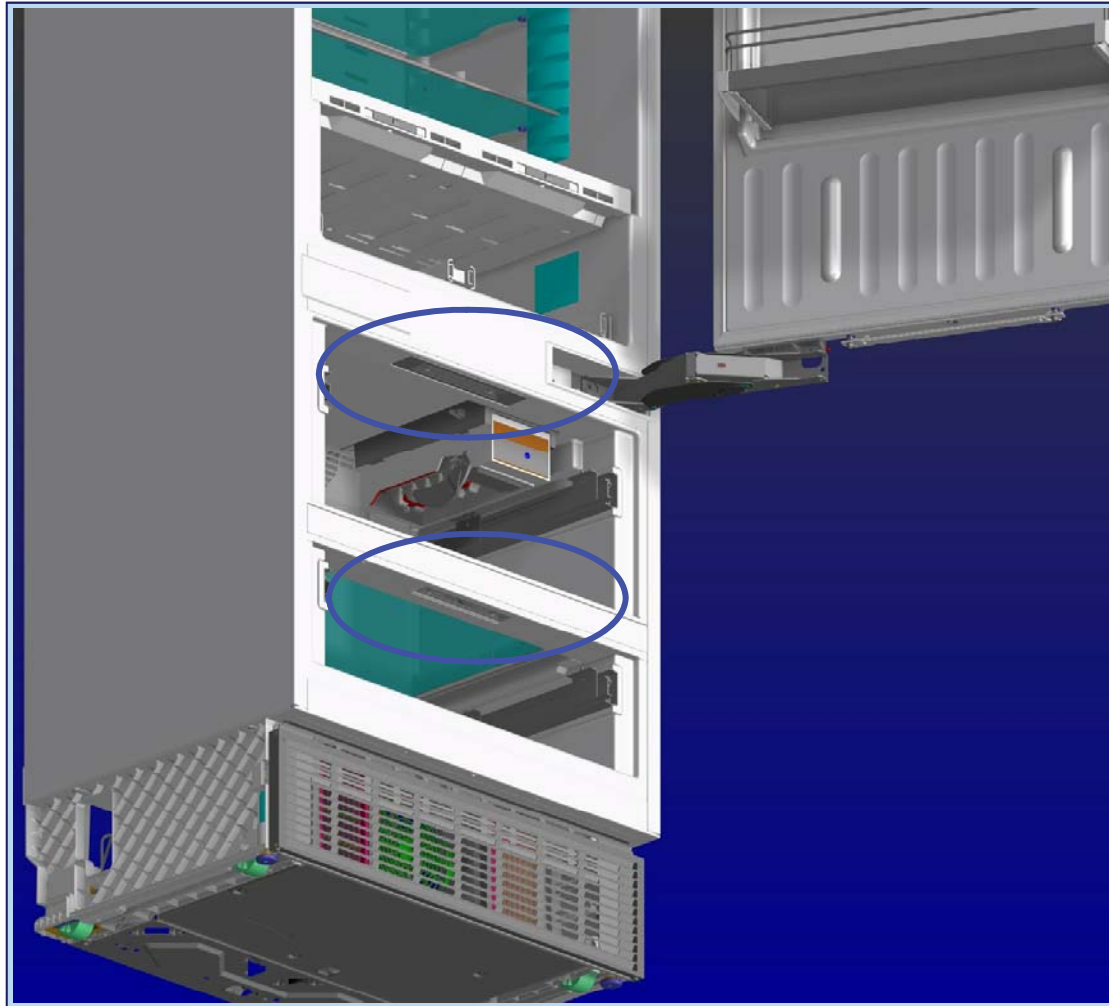



**LED light
lighting for
both freezer
compartments
of HCB 156x**

LIEBHERR

Design, Quality and Innovation 2011

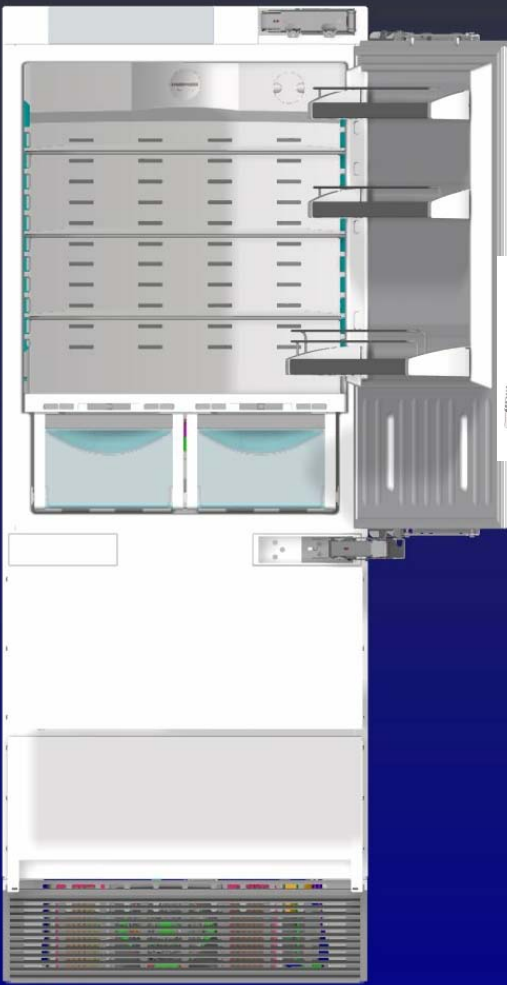
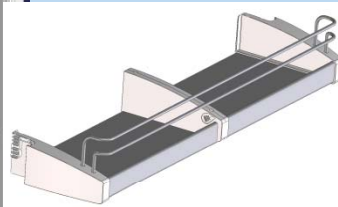
HCB 156x, HC 154x – the differentiation

	<p>Door racks with alu trim, one gallon holder</p>  <p>2 BioFresh safes on telescopic rails, drawers with alu trim</p>	<p>Door racks with stainless trims, no gallon holder, with VarioBox</p>  <p>2 vegetable bins on telescopic rails</p>
--	--	---

LIEBHERR

Design, Quality and Innovation 2011

HCB 156x, HC 154x – the differentiation



Flexible bottle shelf above BioFresh compartment: either bottle storage or glass shelf can be used

Beverage rack



LIEBHERR

Design, Quality and Innovation 2011

HCB 156x, HC 154x – the differentiation

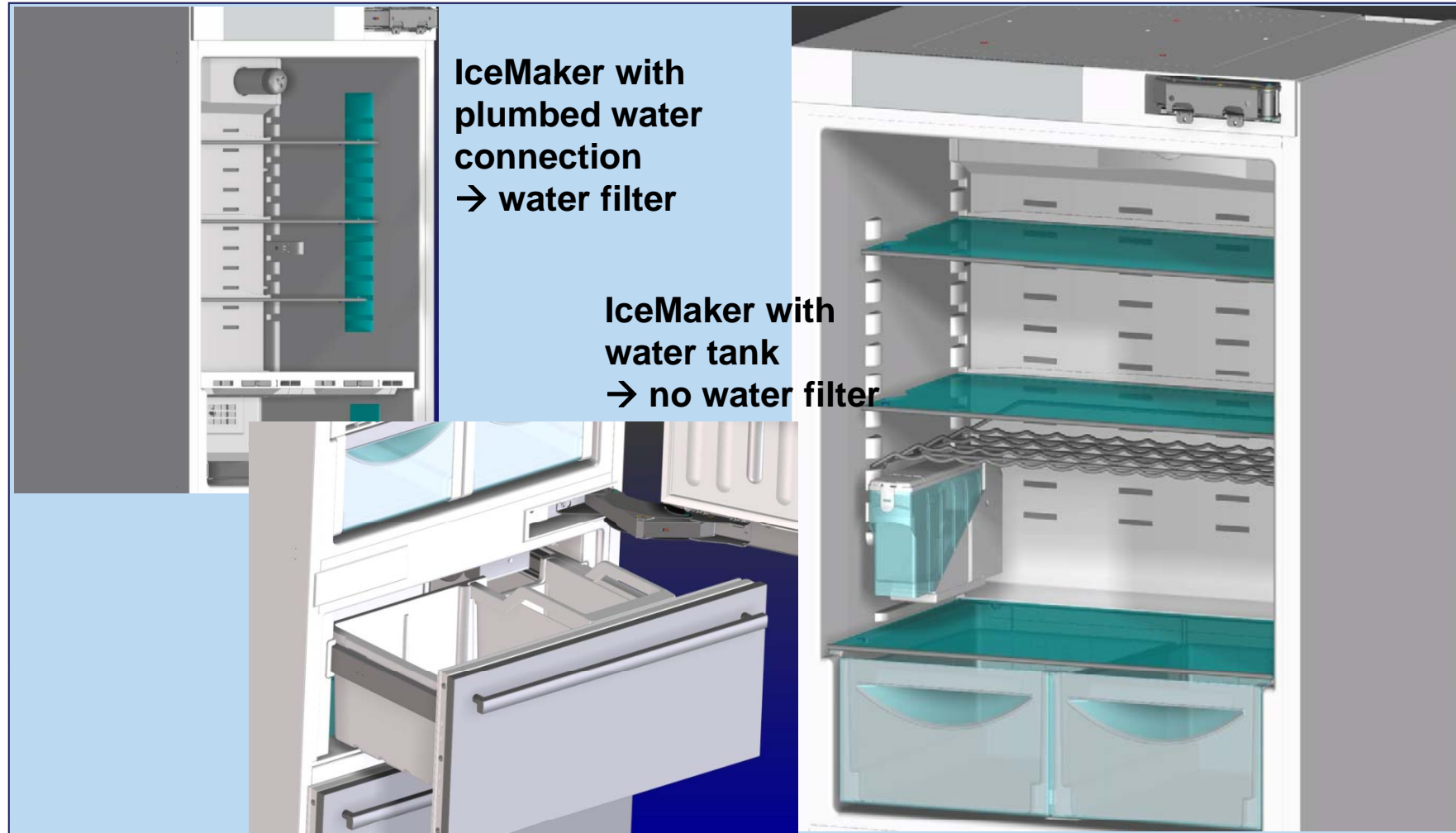

LIEBHERR

Design, Quality and Innovation 2011

Accessories for integrated 30" units

Handles, stainless steel panels and creation of HC(B)S 15xx

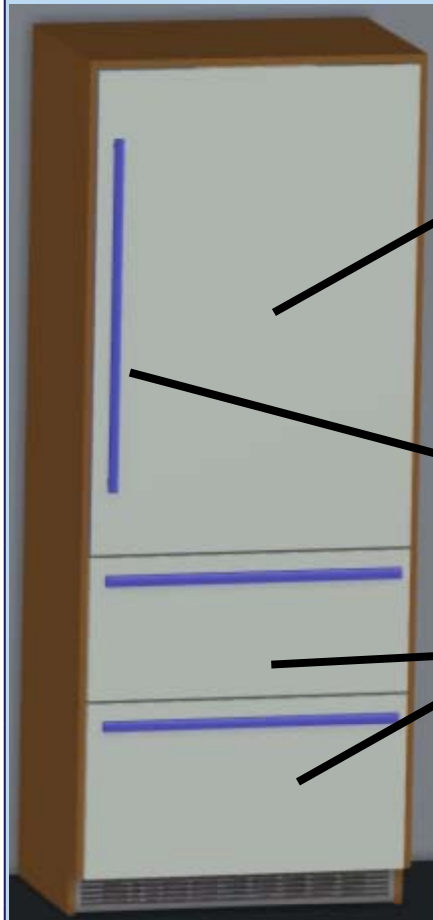

9900 287-00 for 80"
9900 285-00 for 84"

9900 279-00 for $\frac{3}{4}$ " stainless round (3 pcs)
9900 281-00 for aluminium oval (3 pcs)

9900 283-00

9900 223-00 Door reversal kit for HCB / HC 15xx
9900 219-00 SBS kit for HCB / HC 15xx

LIEBHERR